

SAFESTEP FITTING INSTRUCTIONS



SAFESTEP FITTING INSTRUCTIONS

FITTING KIT CONTENTS FK885
(1:1)

1.

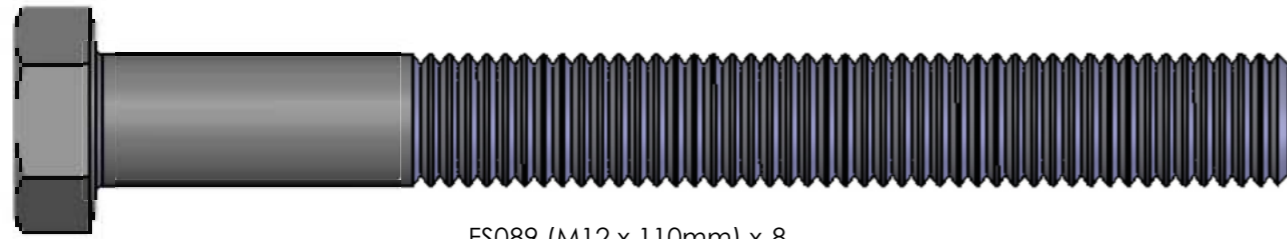

FS089 (M12 x 110mm) x 8

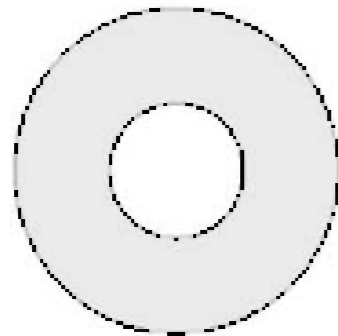

FW026 (M12) x 16



FN034 (M12) x 8



FB006 (M8 x 30mm) x 4

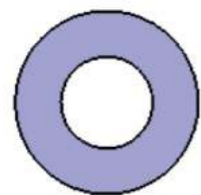

FW021 (M8) x 8



FN006 (M8) x 4

FITTING TIME: 20 Minutes

2.

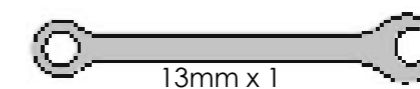
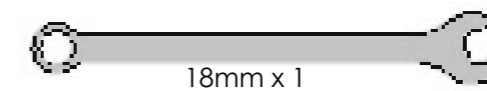
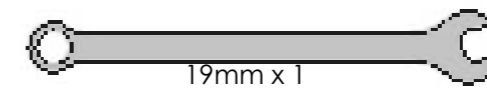
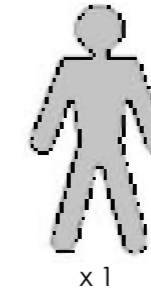

SAFESTEP FITTING INSTRUCTIONS

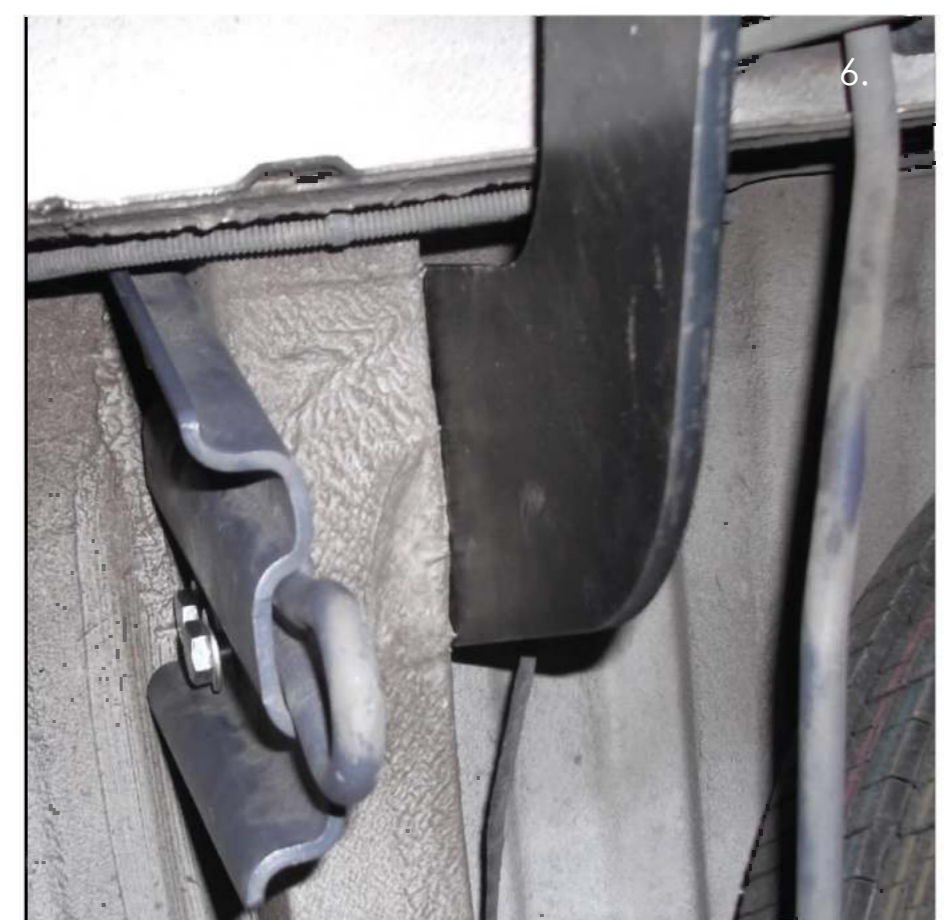
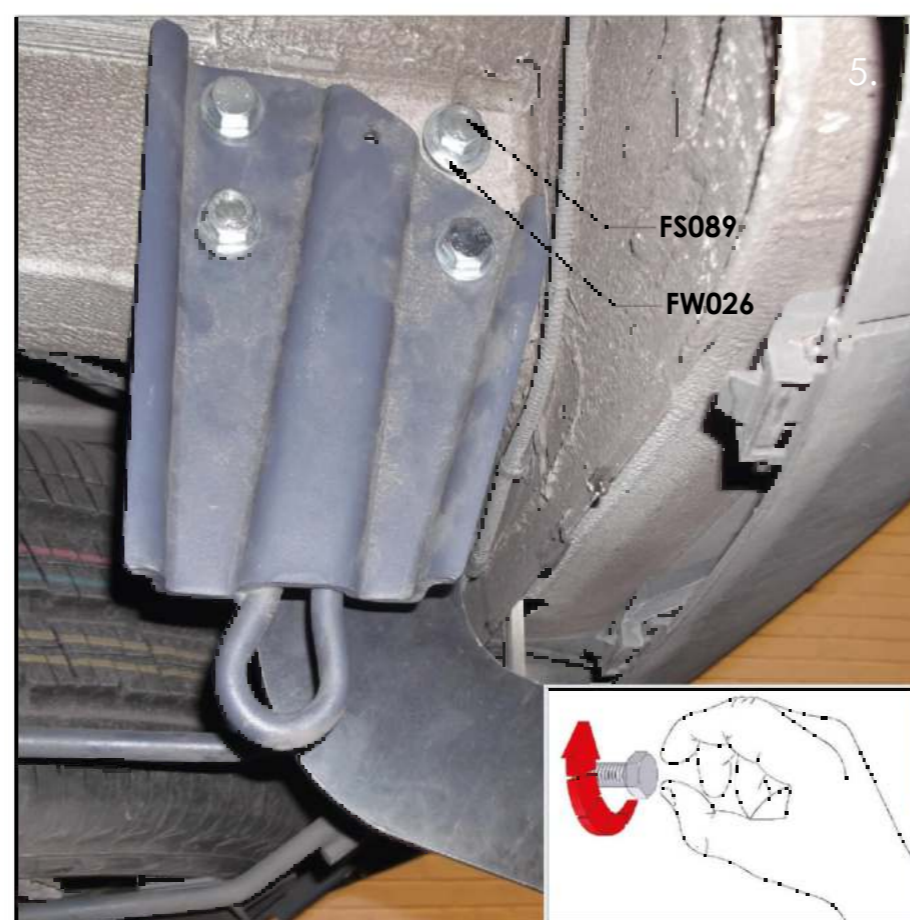
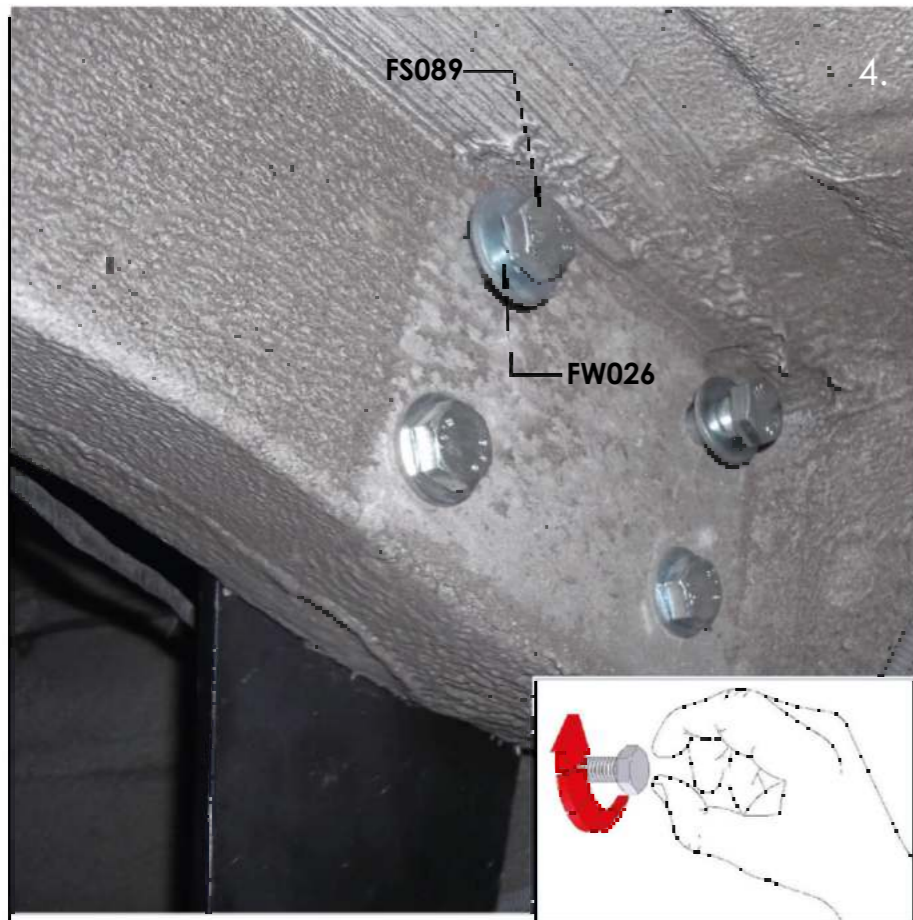
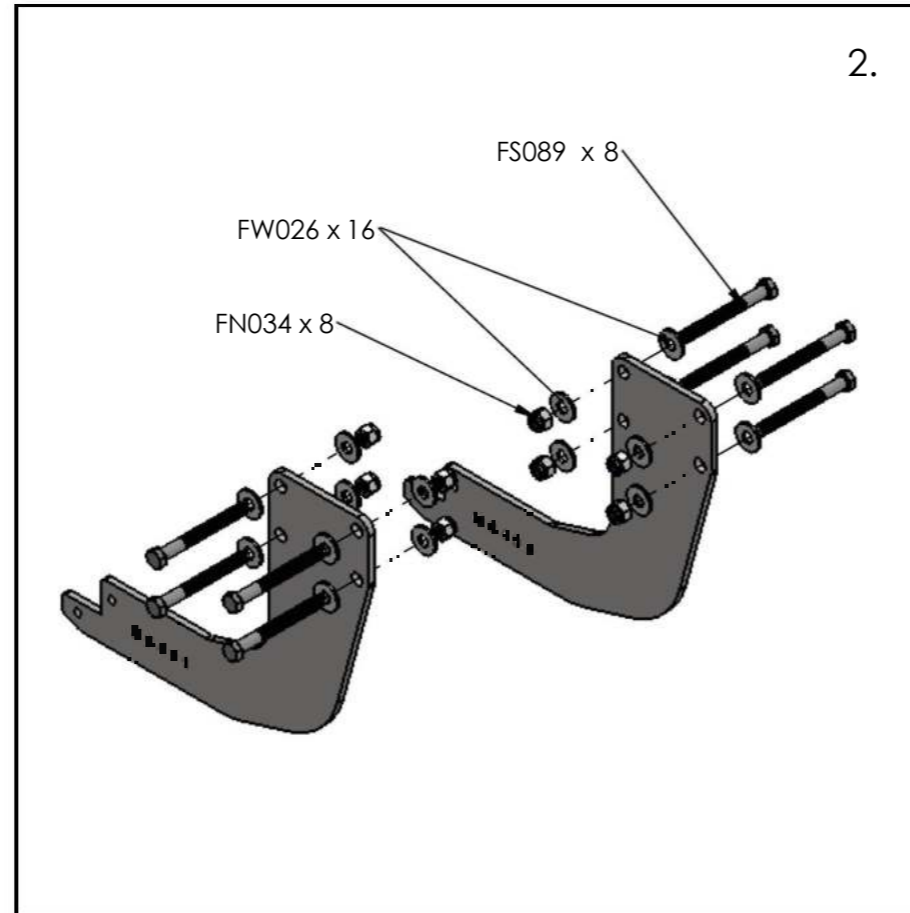
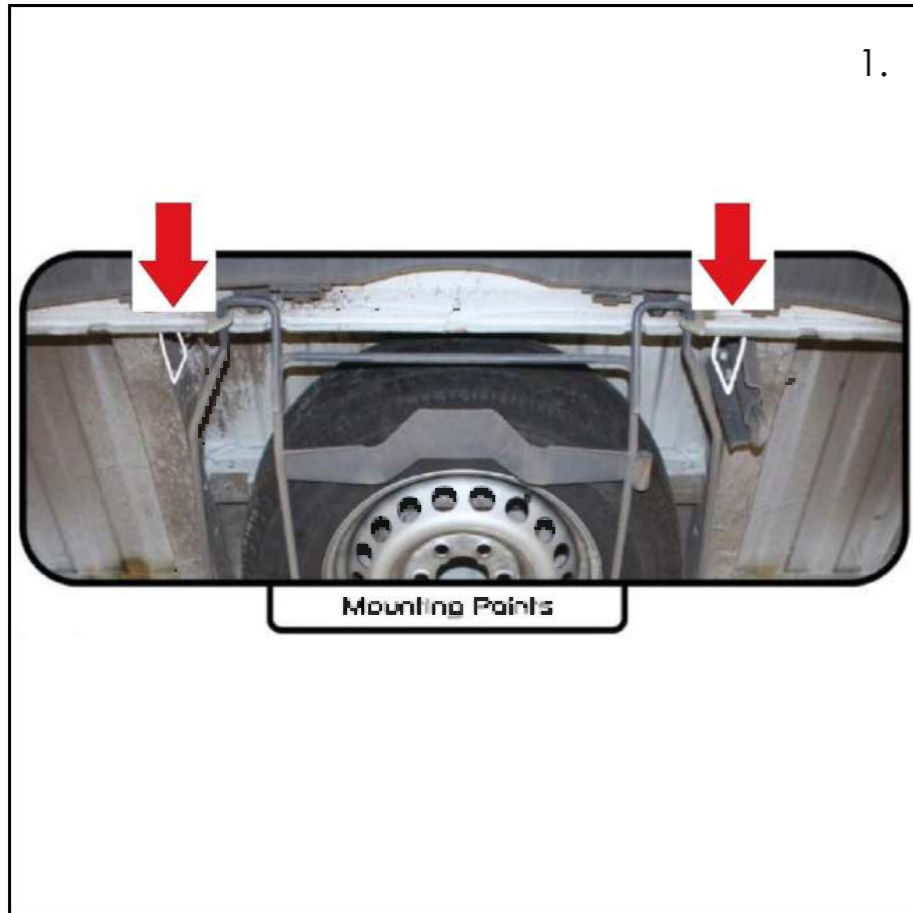

SAFESTEP FITTING INSTRUCTIONS

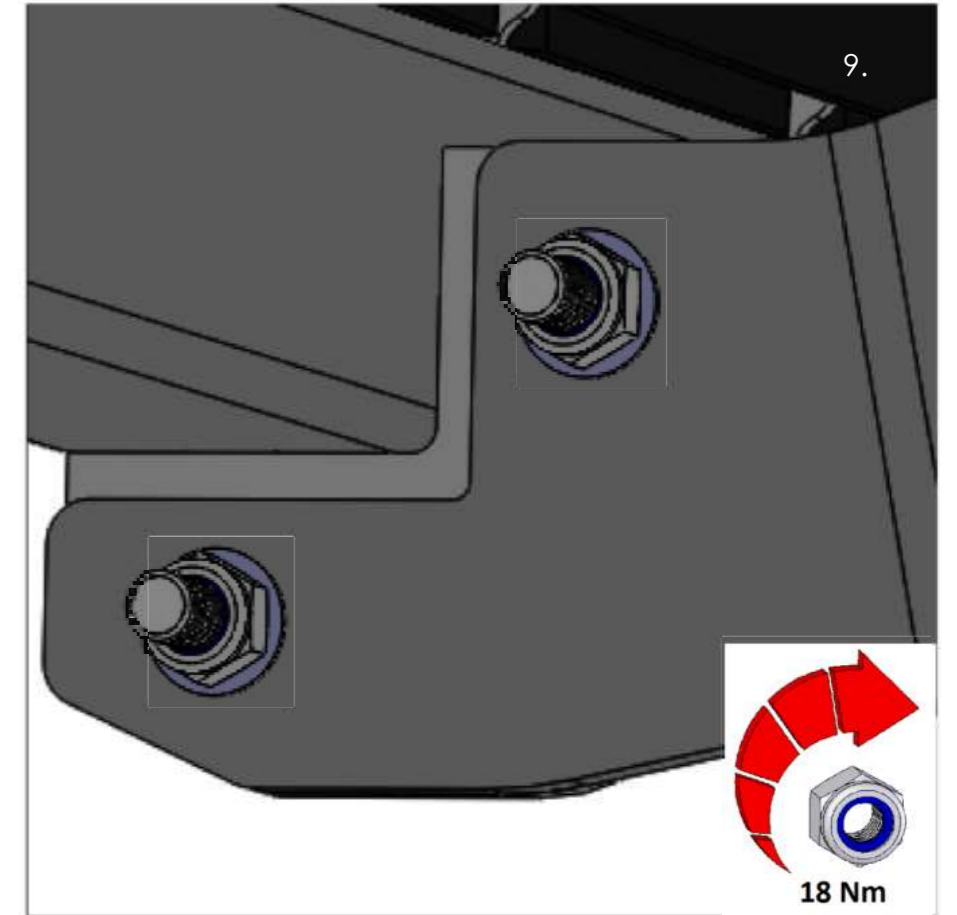
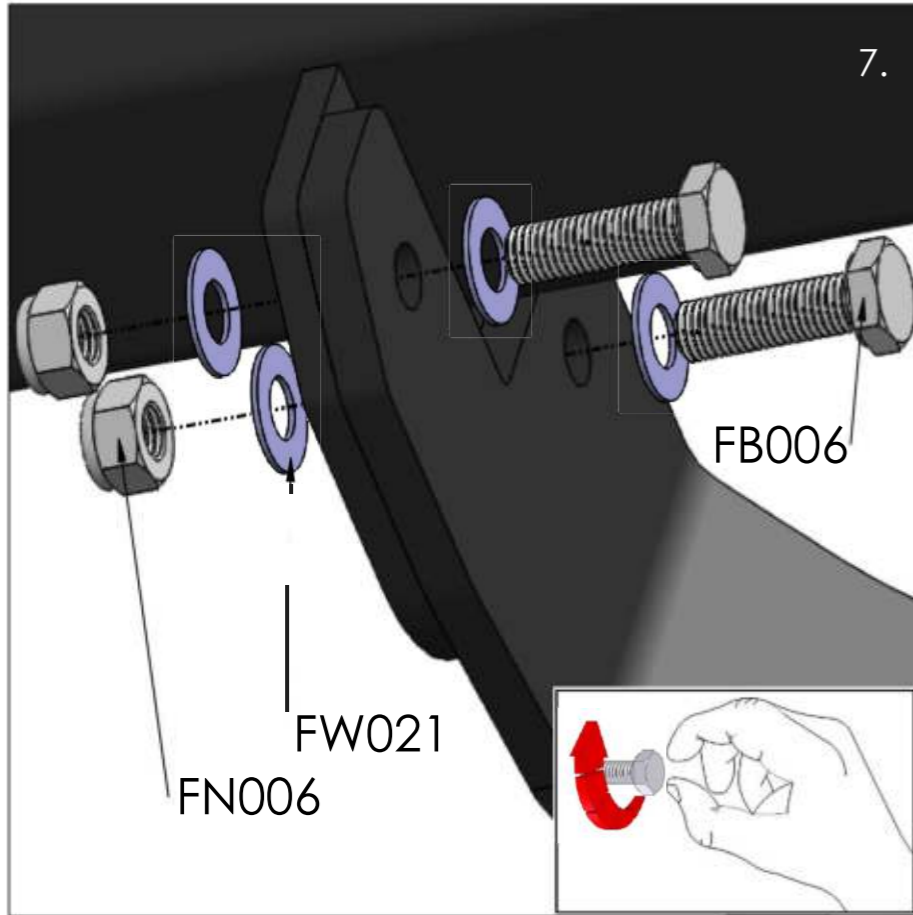

IMPACT STEP FITTING INSTRUCTIONS



FITTING KIT CONTENTS FK885
(1:1)

1.

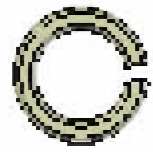

FW020 (M8) x 4



FS089 (M12 x 110mm) x 8

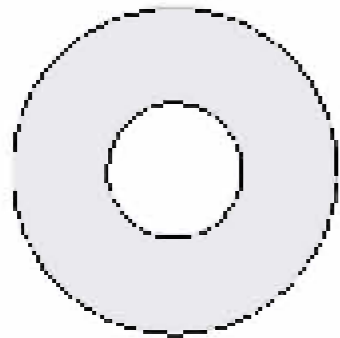

FW026 (M12) x 16



FN034 (M12) x 8

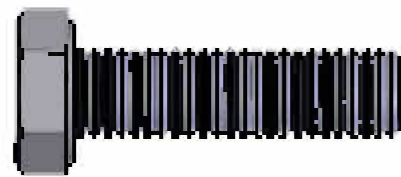

FB006 (M8 x 30mm) x 4

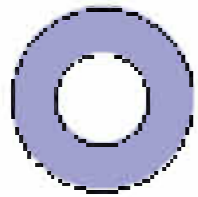

FW021 (M8) x

SAFESTEP	8
IMPACT STEP	4



FN006 (M8) x 4

SAFESTEP	✓
IMPACT STEP	✗

FITTING TIME: 40 Minutes

2.

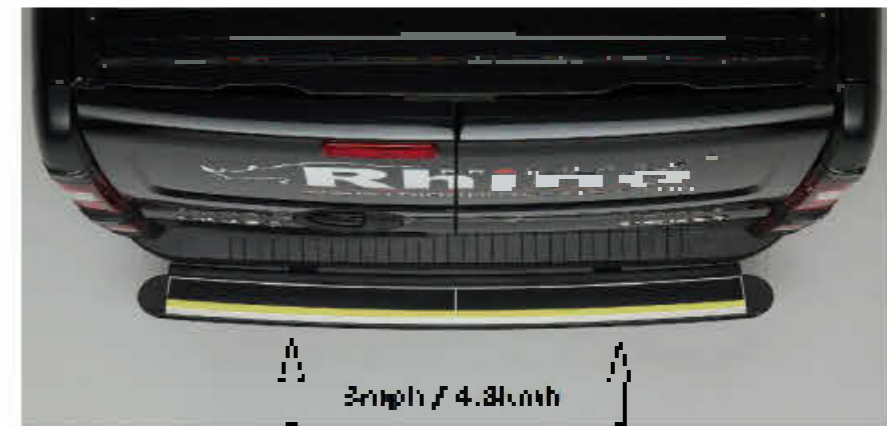
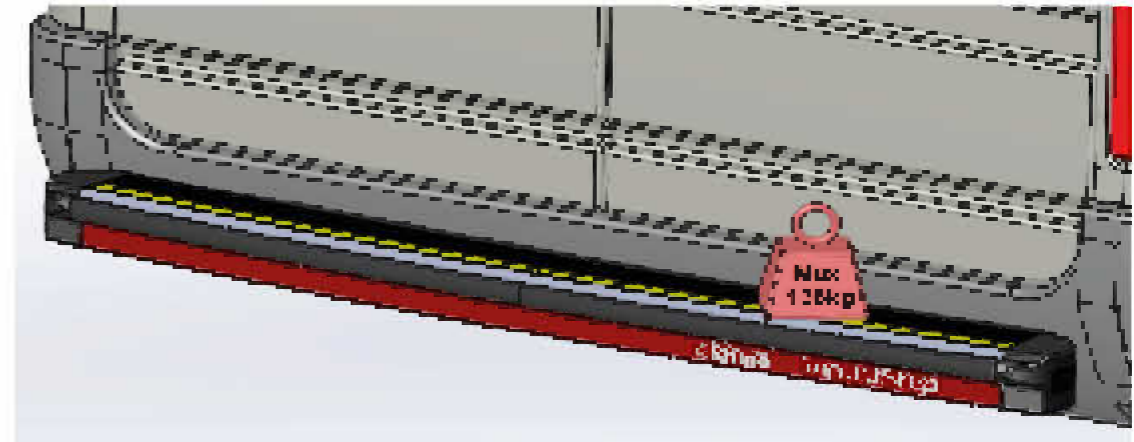

x 1



13mm x 1



19mm x 1



18mm x 1

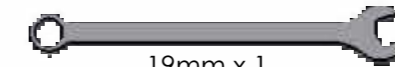

19mm x 1



18mm x 1

IMPACT STEP FITTING INSTRUCTIONS

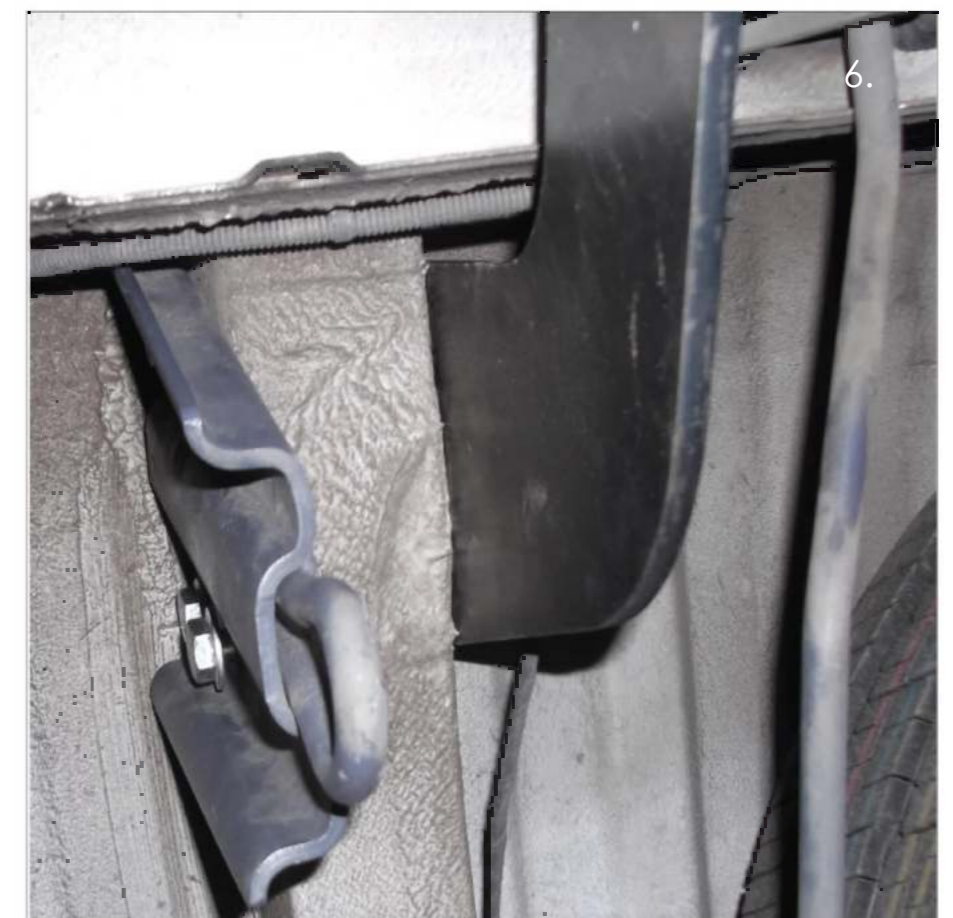
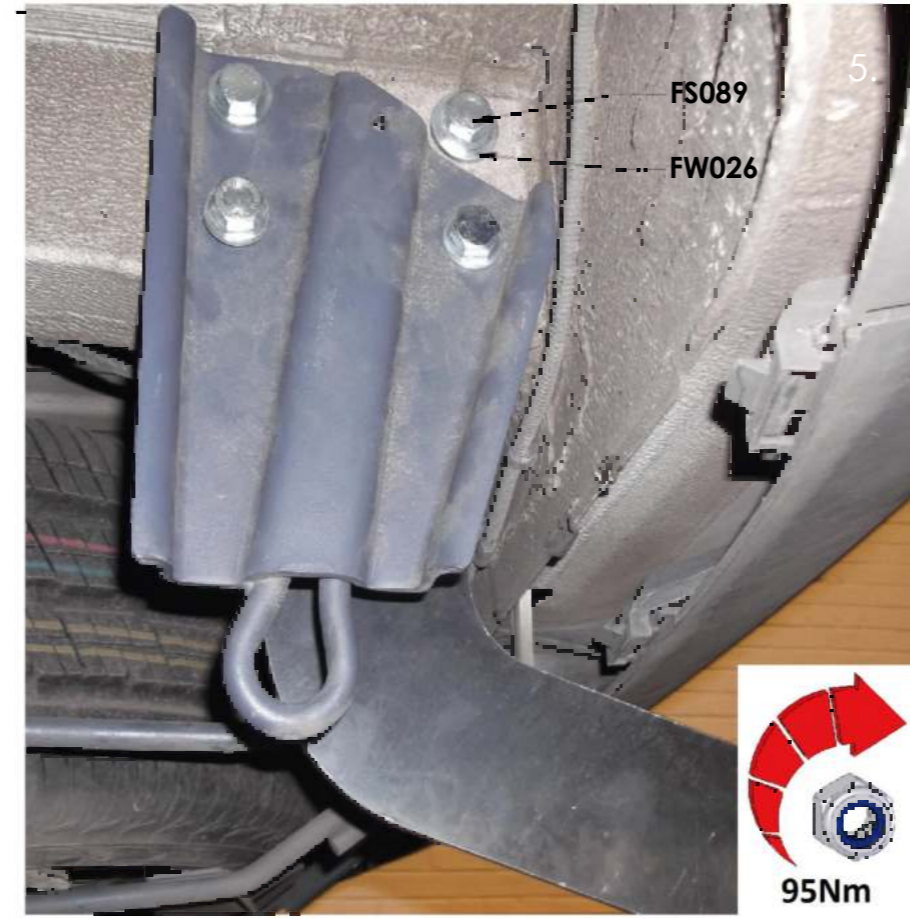
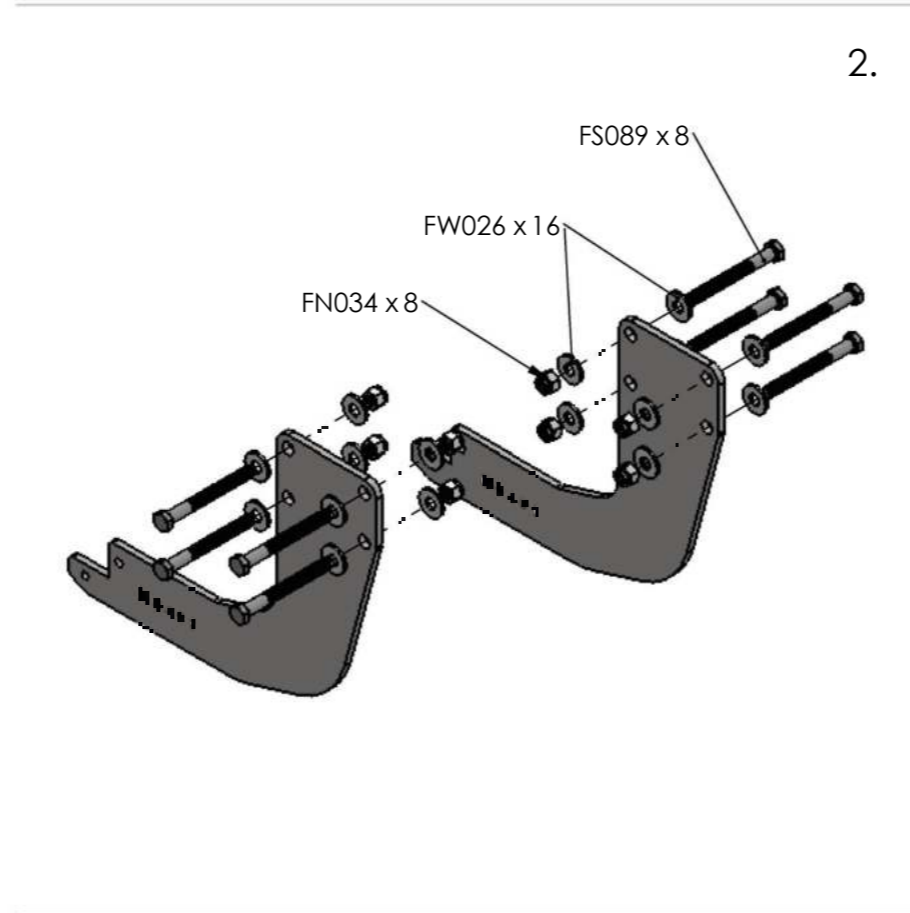
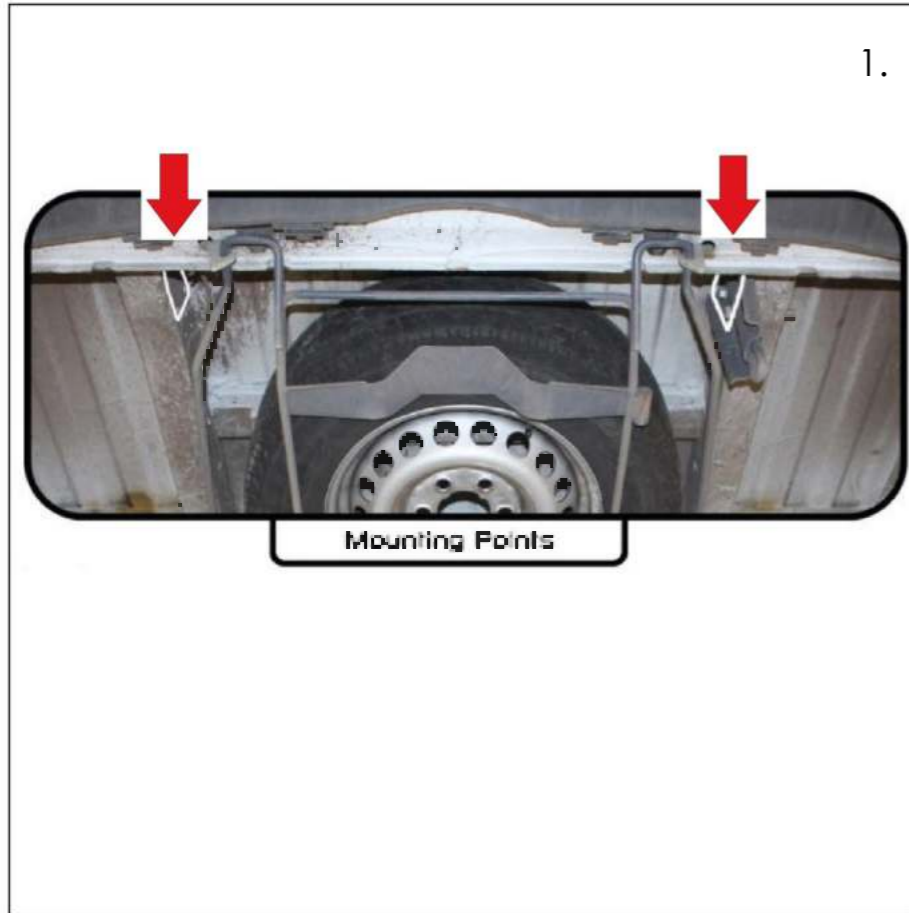

IMPACT STEP FITTING INSTRUCTIONS

