

SAFESTEP FITTING INSTRUCTIONS

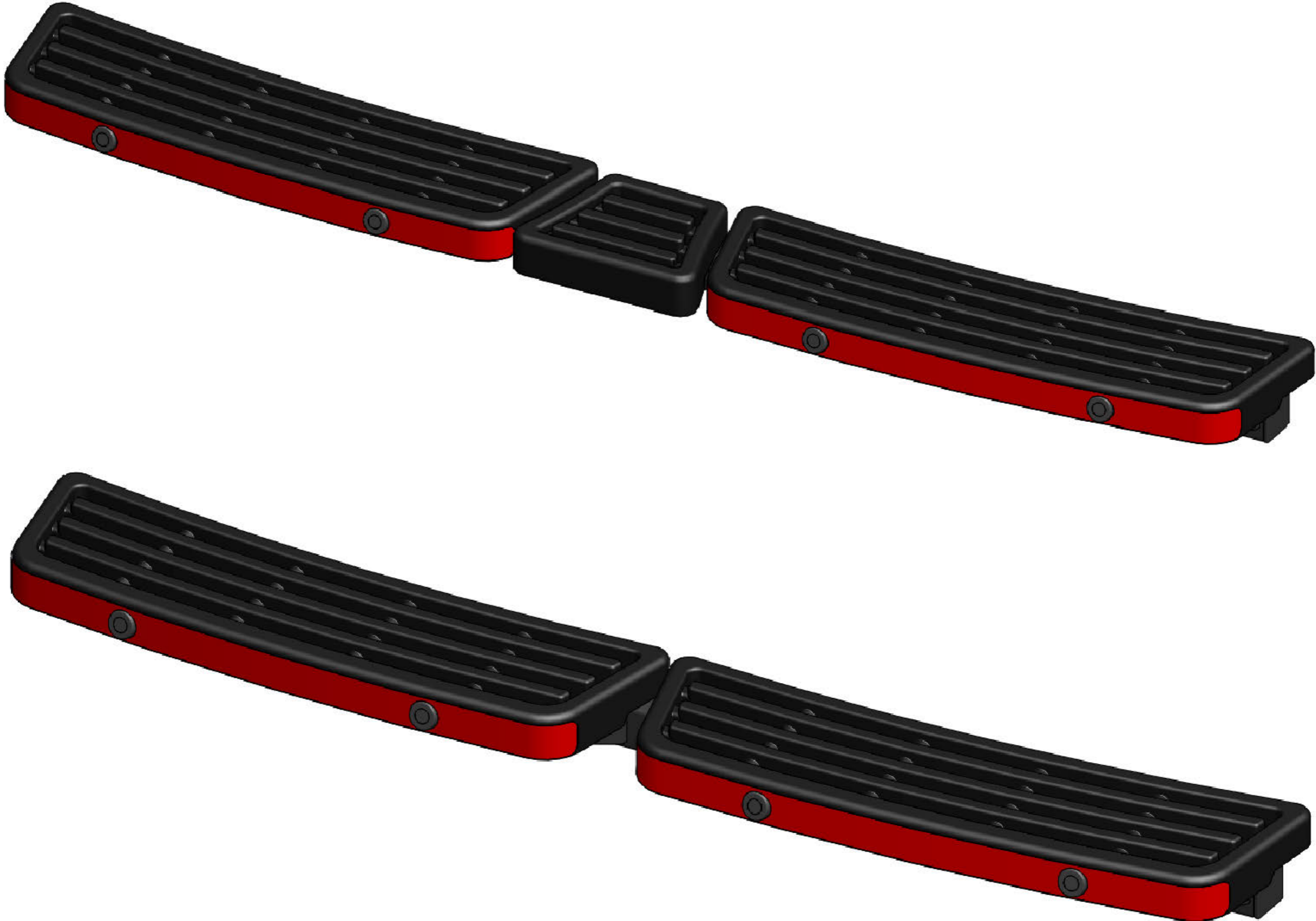

SAFESTEP FITTING INSTRUCTIONS

FITTING KIT CONTENTS FK888
(1:1)



FB006 (M8) x 4



FS082 (M12) x 6

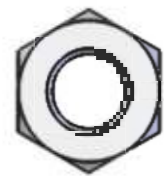

FN006 (M8) x 4

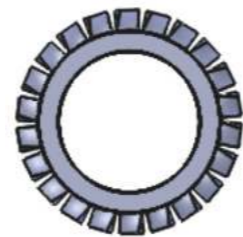

FW029 (M12) x 6



FW021 (M8) x 8

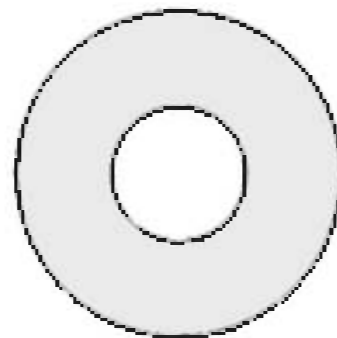

FW026 (M12) x 6

FITTING TIME: 30 Minutes

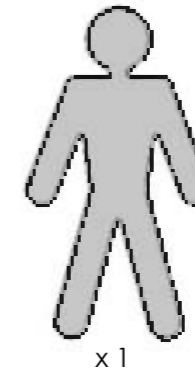

19mm x 1

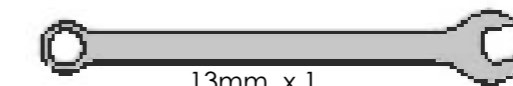

13mm x 1

13mm x 1

SAFESTEP FITTING INSTRUCTIONS

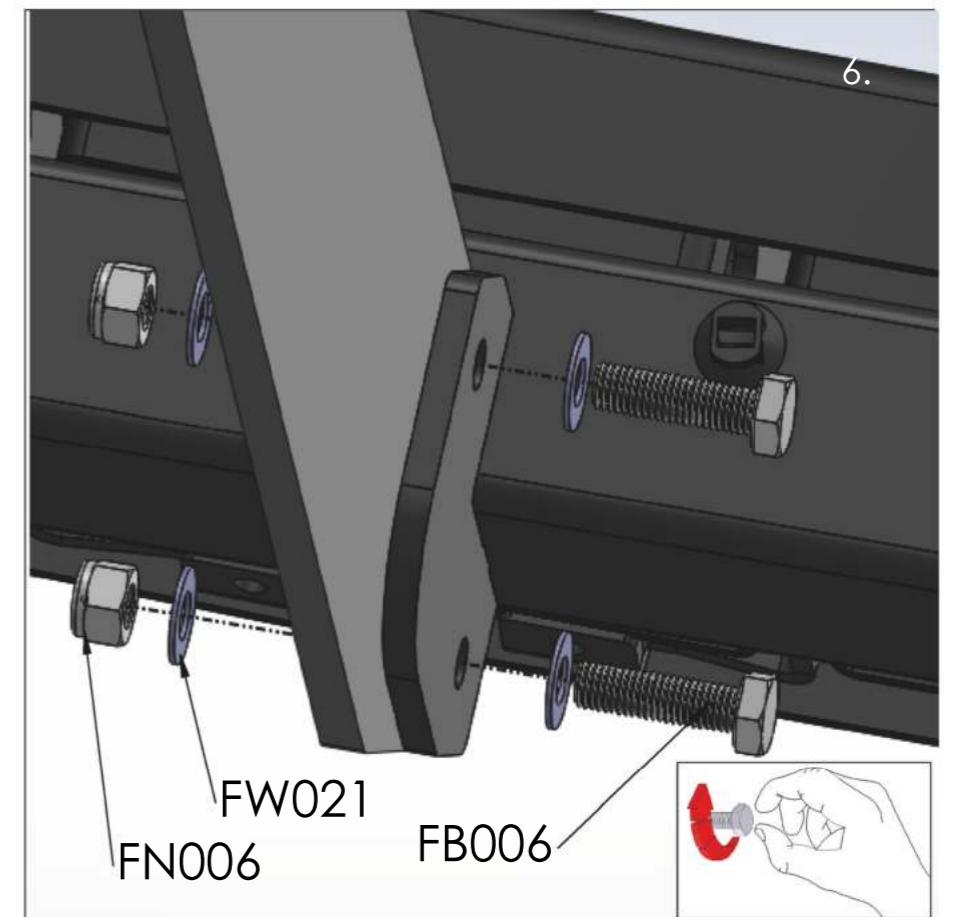
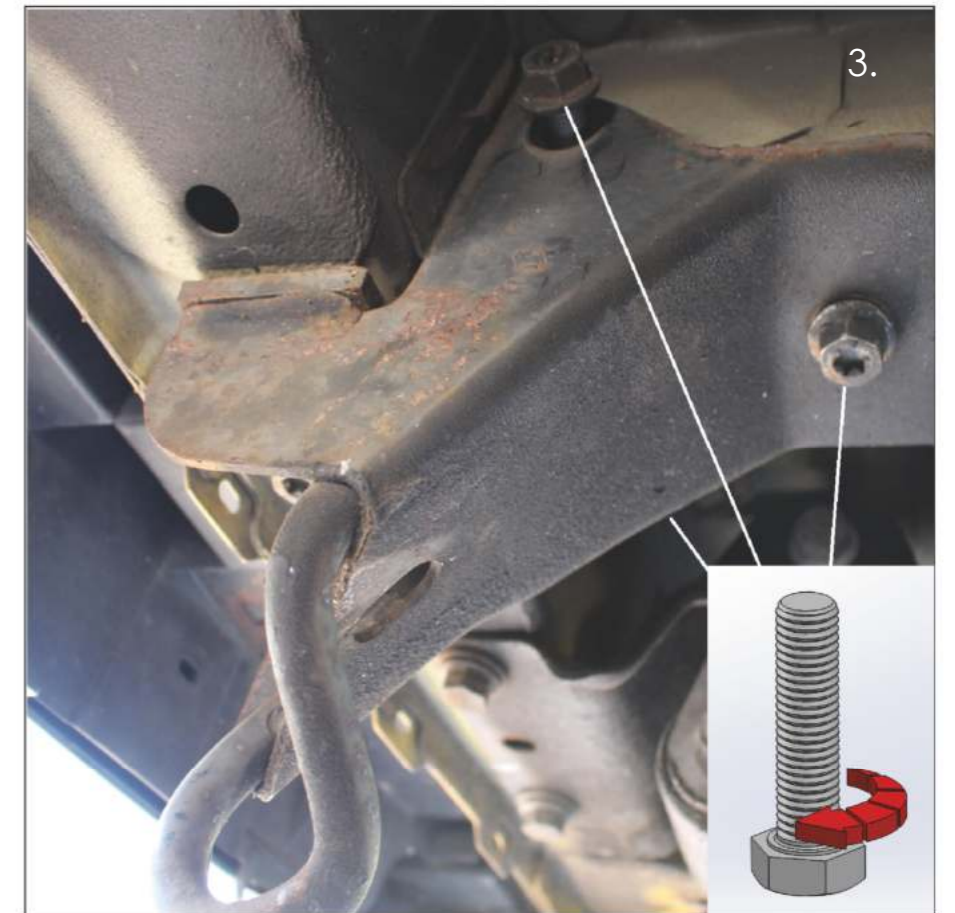
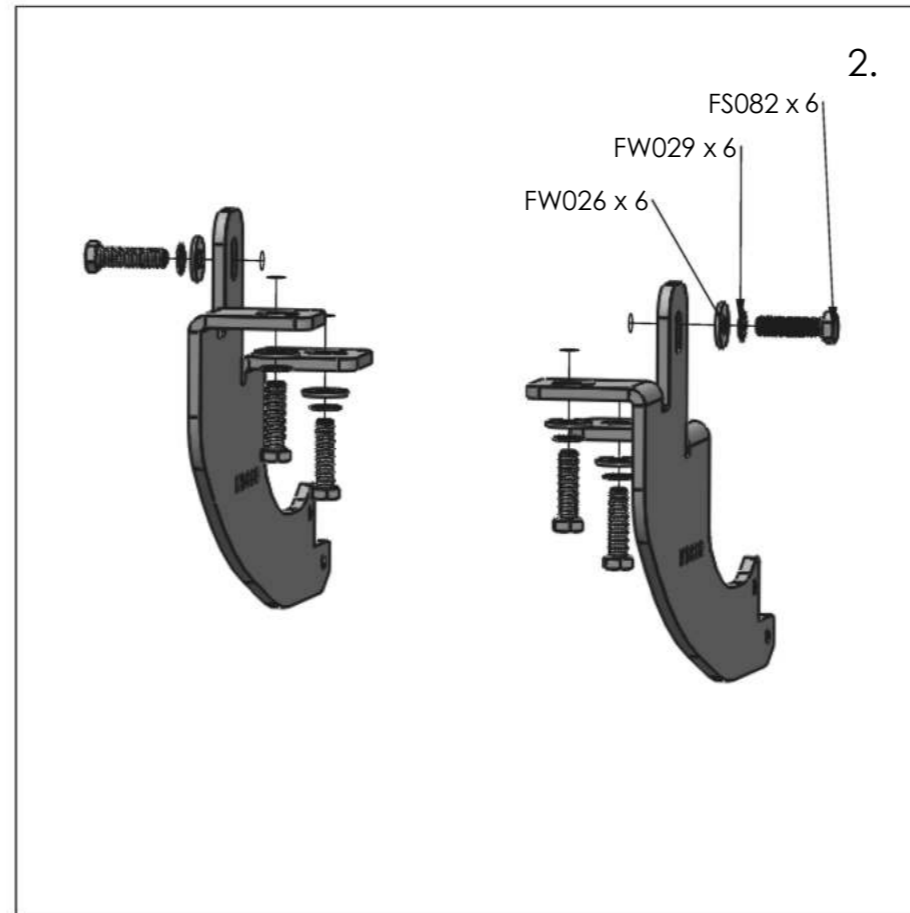
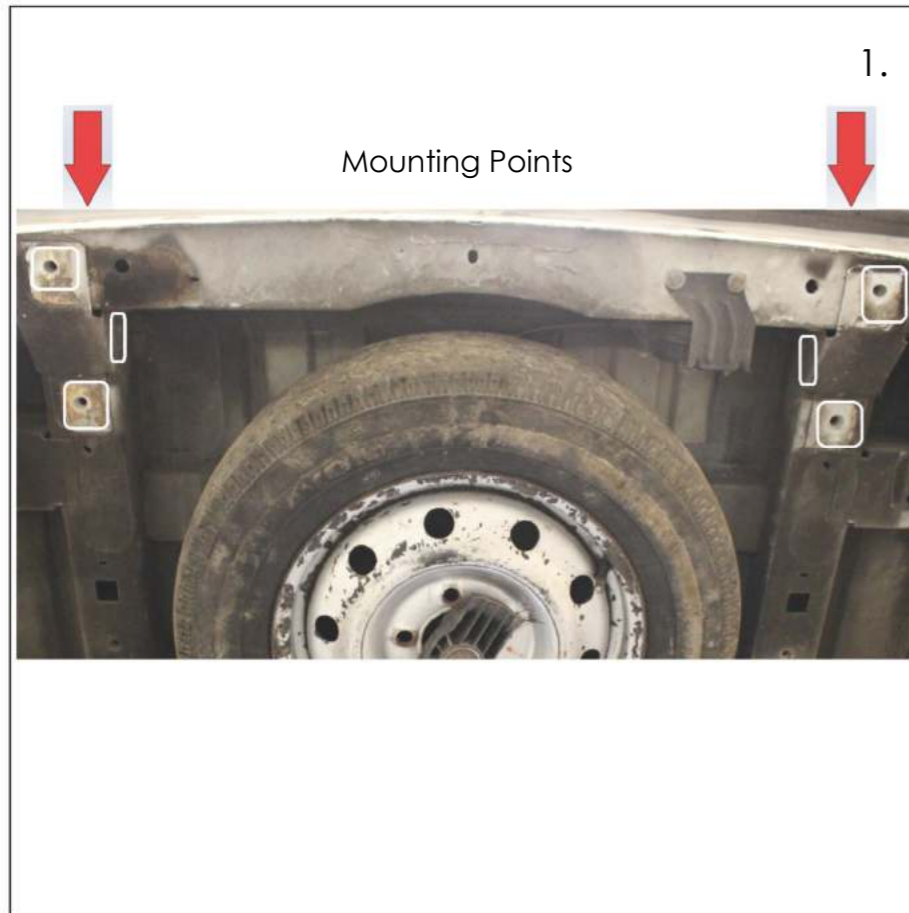

SAFESTEP FITTING INSTRUCTIONS

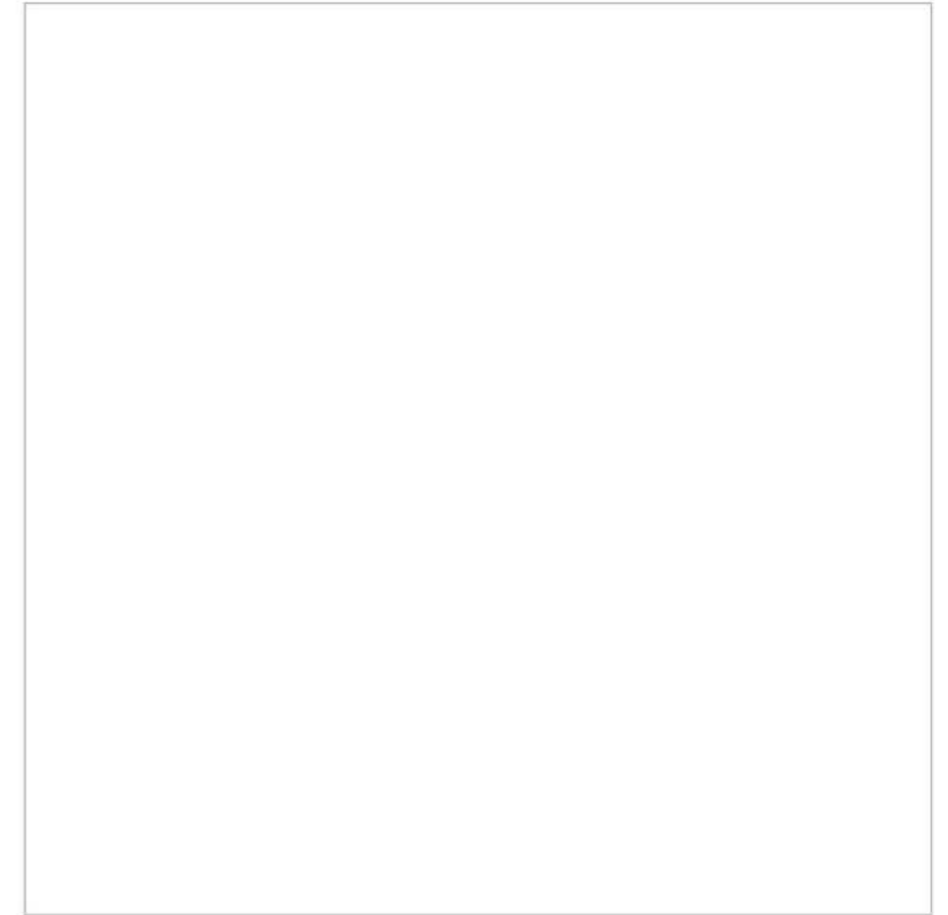
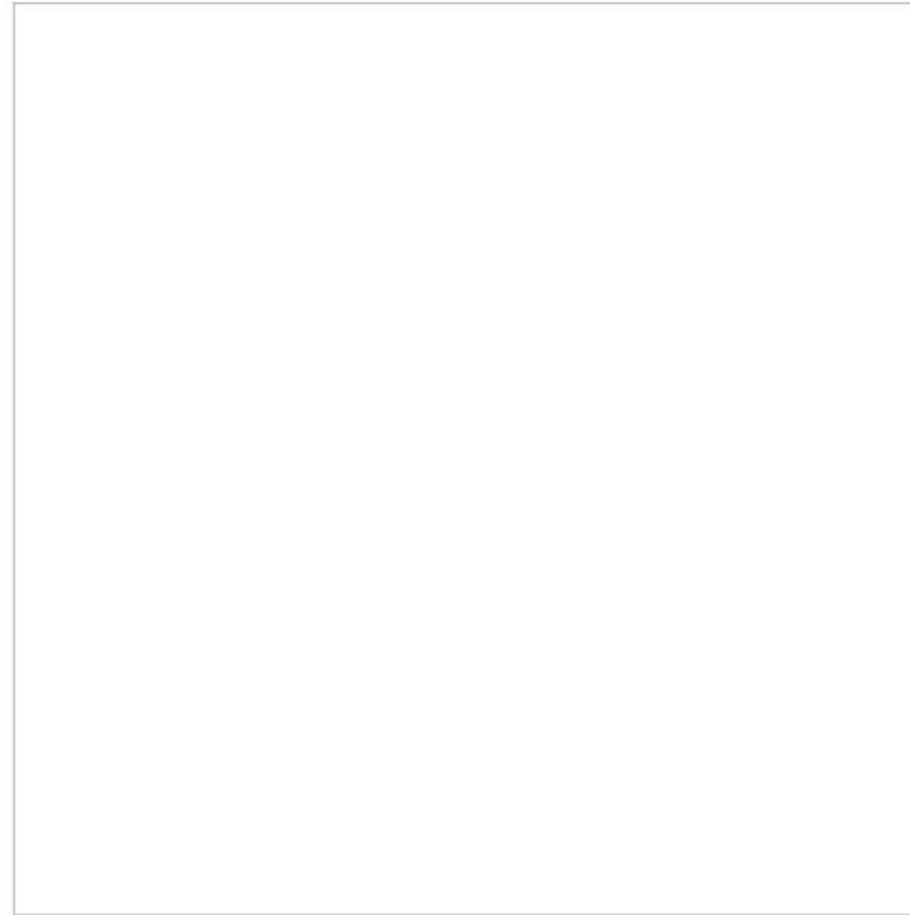
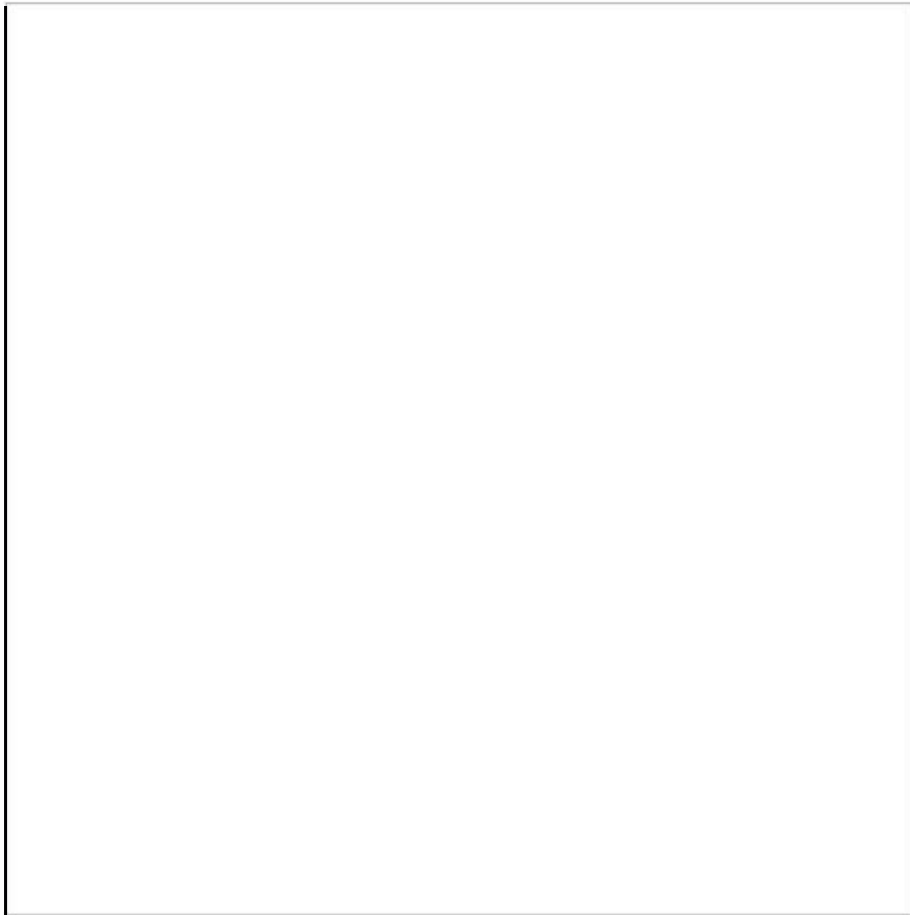

IMPACT STEP FITTING INSTRUCTIONS

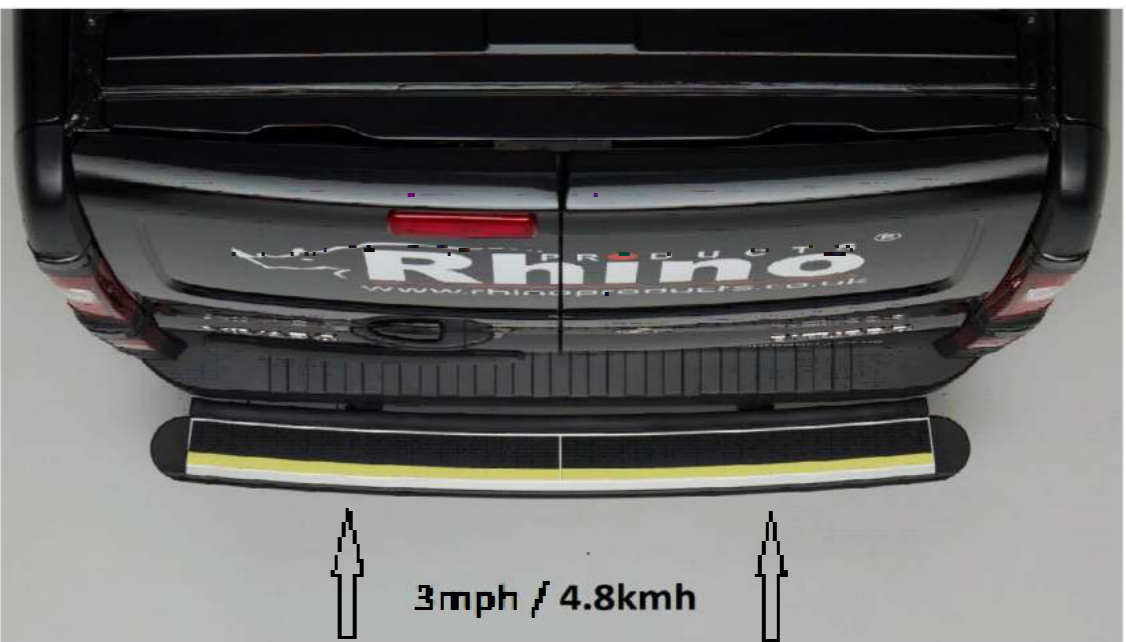

IMPACT STEP FITTING INSTRUCTIONS

FITTING KIT CONTENTS FK888 (1:1)

1.



FW020 (M8) x 4

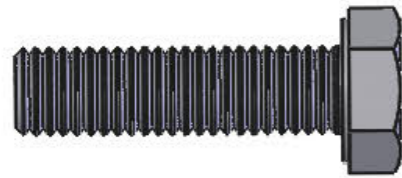

FB006 (M8 x 30) x 4

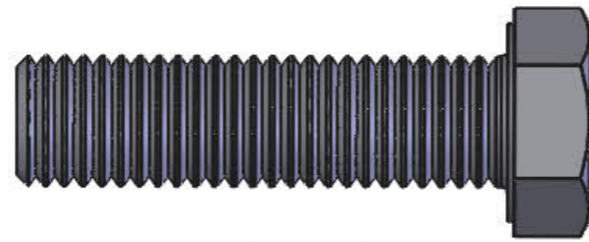

FS082 (M12 x 45) x 6

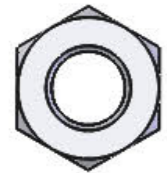

FN006 (M8) x 4

SAFESTEP	✓
IMPACT STEP	✗

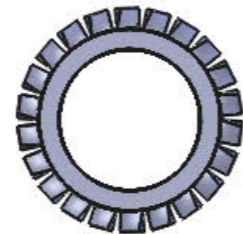

FW029 (M12) x 6

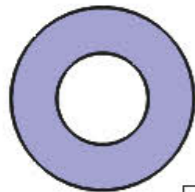

FW021 (M8) x

SAFESTEP	8
IMPACT STEP	4

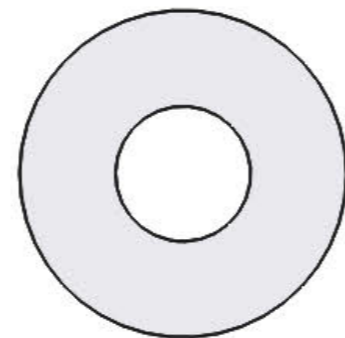

FW026 (M12) x 6

FITTING TIME: 40 Minutes

2.



x 1

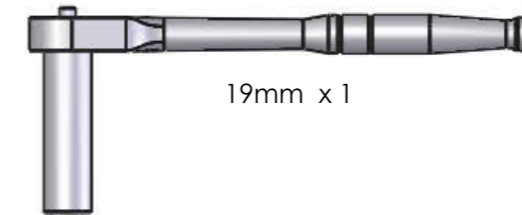

19mm x 1



13mm x 1

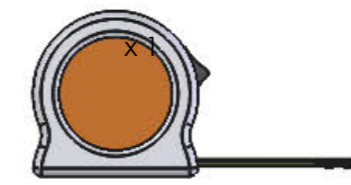

IMPACT STEP FITTING INSTRUCTIONS

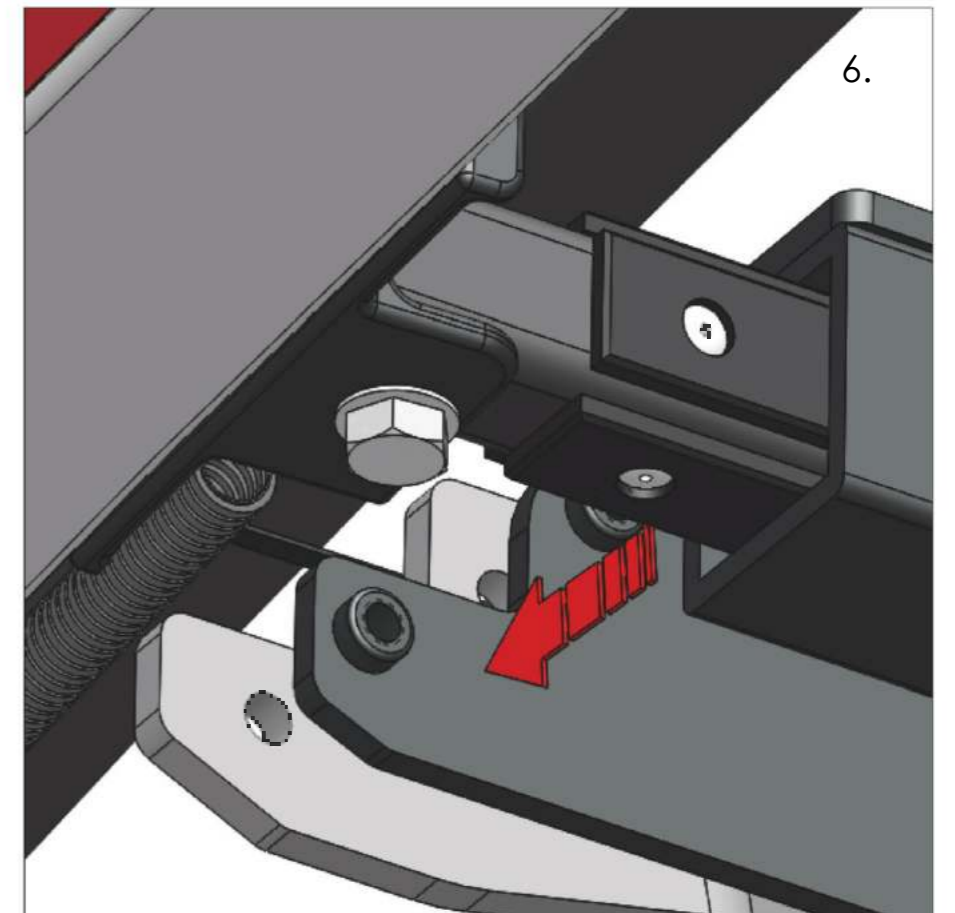
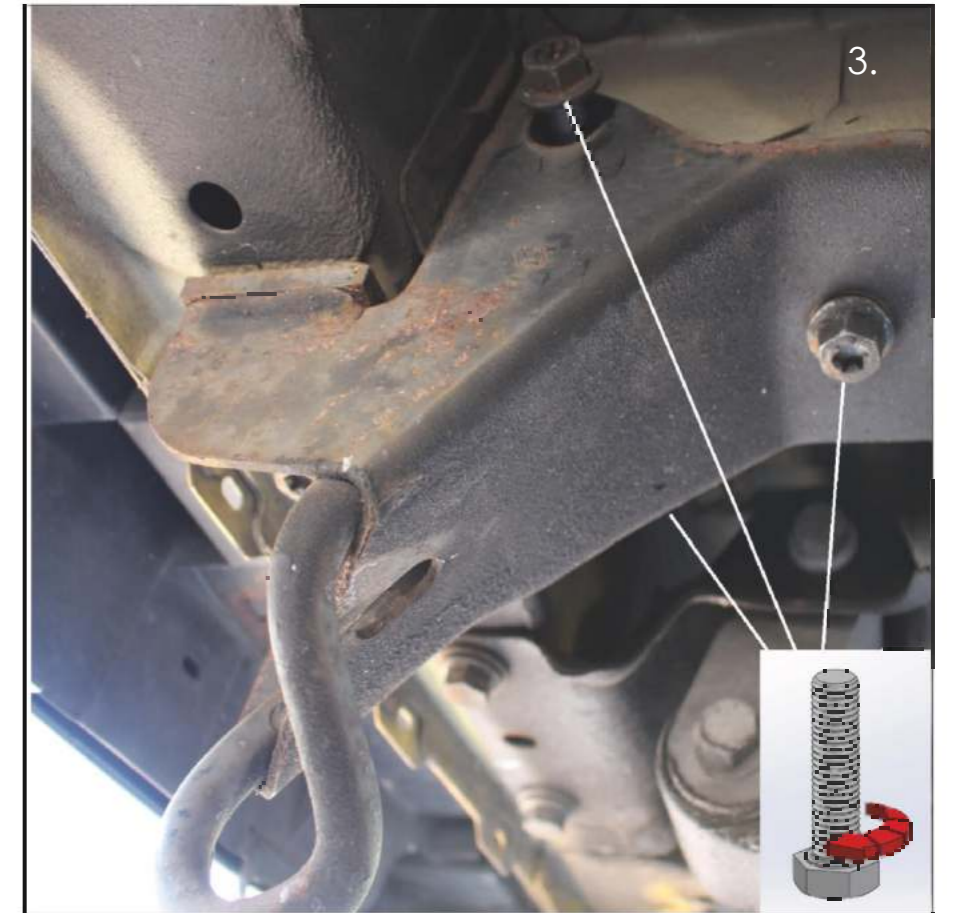
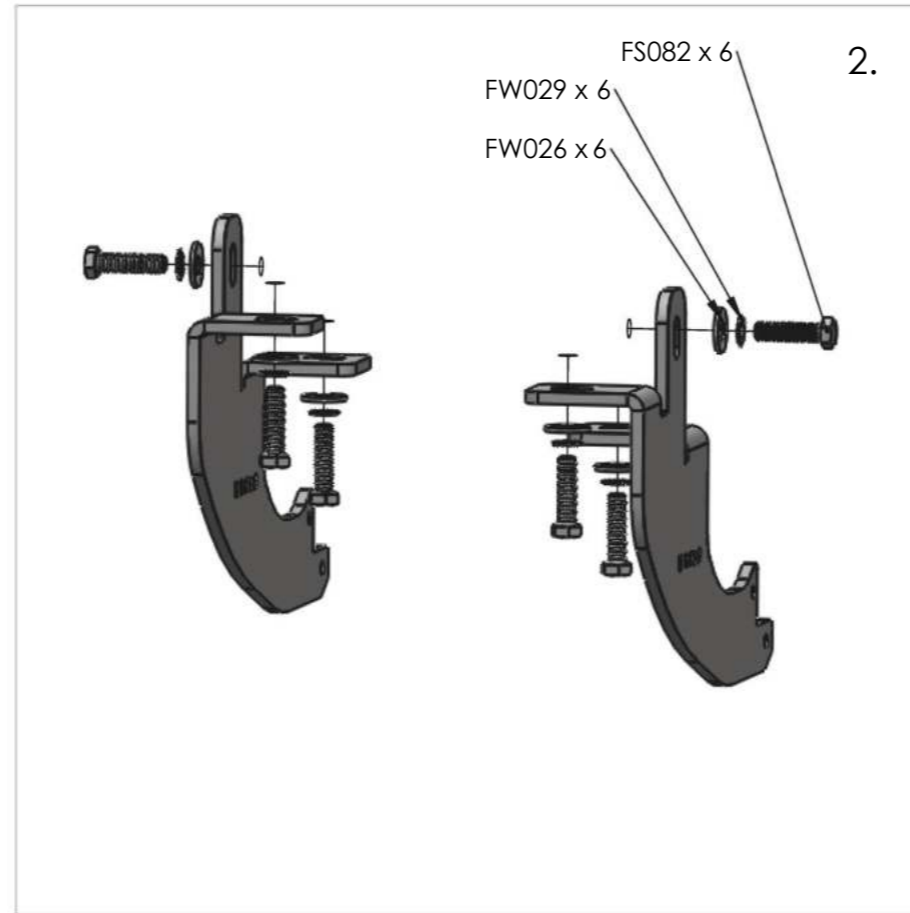
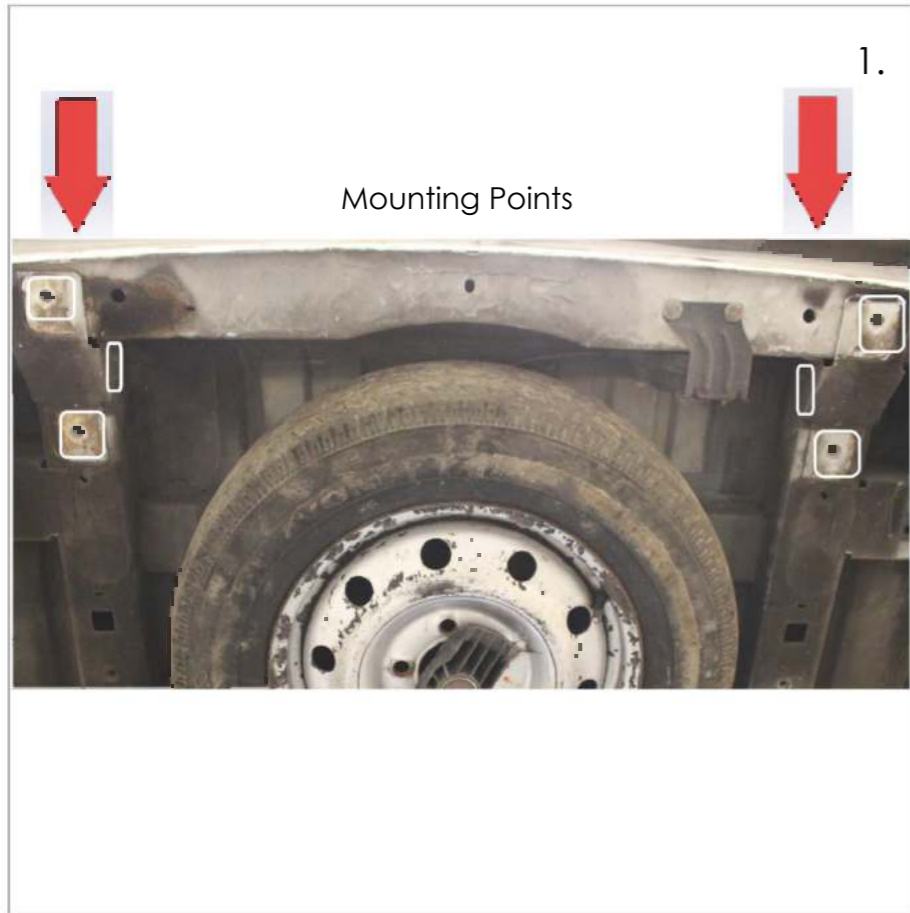

IMPACT STEP FITTING INSTRUCTIONS

